

Zodiac Proline M

80M/100M/400M

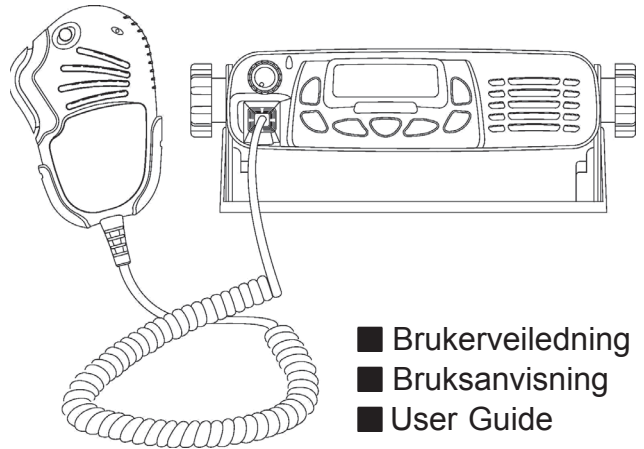

- Brukerveiledning
- Bruksanvisning
- User Guide

ZODIAC

■ INNHOLD

INTRODUKSJON	3	VOX	16
EGENSKAPER	3	VOX nivå	17
SIKKERHETSANVISNINGER	3	Auto VOX	17
BESKRIVELSE AV STASJONEN	4	Prioritets scanning	18
BESKRIVELSE AV DISPLAYET	5	Prioritetskanal ved scanning	18
BESKRIVELSE AV TASTENE	5	Strømsparing	19
FORBEREDELSE FØR BRUK	6	Talk Around	19
SLÅ RADIOEN PÅ/AV	7	Passord	20
MENYOVERSIKT	8	Passord kanal	20
FUNKSJONER	9	Dimmer	21
Kanalvalg	9	Scrambler	21
Sending	9	Statusanrop	22
Ubesvarte anrop	9	Slette liste	22
Kontaktliste	10	Mikrofonstyrke	23
Liste over statusanrop	10	Reset	23
Lone Worker	11	Variable anrop	24
Tx power	11	TEKNISKE SPESIFIKASJONER	25
Tx tone	12	KANALER	26
Rx tone	12	Frekvenstabell	26
Gruppe	13	Pilottonetabell	26
Alarmtone	13	TILBEHØR	27
Tastelås	14	FEILSØKING	27
Squelch nivå	14	VEDLIKEHOLD	27
Auto squelch	15	GARANTI	28
Scanning	15	SAMSVARSERKLÆRING	28
DTMF	16		

INTRODUKSJON

Zodiac Proline M er en kommunikasjonsradio beregnet for krevende samband i yrkessammenheng. Den er laget for å kunne tilpasses forskjellige typer radionett da den er utstyrt med selektivt anropssystem (inntil 7 toner). Den er også en bredbåndsradio, som betyr at det kan være stor frekvensforskjell mellom kanalene i det aktuelle båndet.

EGENSKAPER

Zodiac Proline M er en mobilstasjon for montering i biler, spesielt laget for yrkesbruk i tøffe miljøer. Den er robust og enkel i bruk. Den inneholder et enkelt, men likevel kraftig menysystem. Senderen gir inntil 15W, som gir god rekkevidde. Radioen har en kraftig audioforsterker, som gir en klar lyd. Displayet har mulighet for alfanumerisk visning av kanaltekst

SIKKERHETSANVISNINGER

Det er viktig å følge noen enkle retningslinjer for bruk av radioen. Dette for å oppnå lang levetid for apparatet.





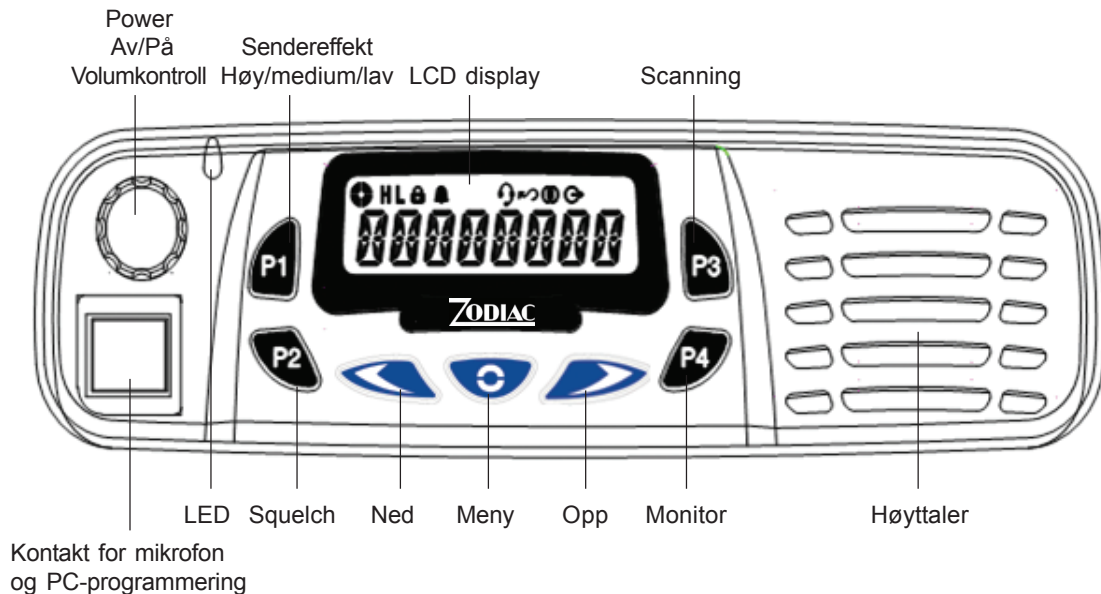

- Ha alltid antennen påskrudd ved sending.
- Apparatet er godkjent for å tåle fukt og vann, men bør tørkes etter bruk.
- Apparatet tilkoples godkjent strømforsyning på 12V DC, eller direkte til bilens 12V anlegg. Dette er viktig for å få stasjonen til å gi spesifisert sendereffekt, samt gi rene og gode signaler.

BESKRIVELSE AV STASJONEN





BESKRIVELSE AV DISPLAYET



-  Signalstyrkenivå
- HL** Sendereffekt indikator
H = høy sendereffekt
L = lav sendereffekt
M = medium sendereffekt (vises ikke i displayet)
-  Tastelås
-  Alarmtoneindikator
-  VOX indikator
-  Scan indikator
-  Scrambler indikator (taleforvrenger)
-  Talk around indikator (direkte samband)

BESKRIVELSE AV TASTENE

-  **Meny-tast**
Brukes for å få tilgang til menyen og for å bekrefte menyvalg
-  **OPP-tast**
Velger ønsket kanal eller blar oppover i menylisten.
-  **NED-tast**
Velger ønsket kanal eller blar nedover i menylisten.
- P1** Velger sendereffekt
- P2** Velger ønsket squelch-nivå
- P3** Starter scanning av programmerte kanaler
- P4** Monitor knapp. Åpner tonemottaker, og kan resette denne etter anrop.

Tastene P1, P2, P3 og P4 kan programmeres etter eget ønske for å aktivere bestemte funksjoner. Programmeringen utføres av din forhandler.

■ FORBEREDELSE FØR BRUK

■ Montering av festebrakett

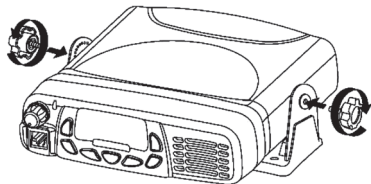

■ Montering av strømkabel

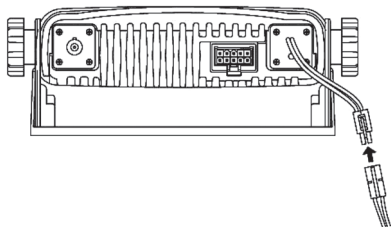

■ Montering av håndmikrofonen

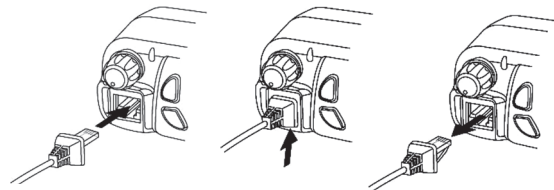

■ Montering av mikrofonbrakett

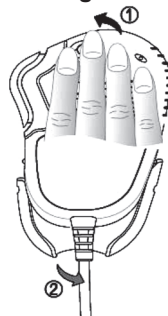

■ SLÅ RADIOEN PÅ/AV

■ Slå på radioen

For å slå på radioen, skru av-på/volumknappen til høyre.

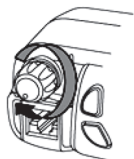

■ Slå av radioen



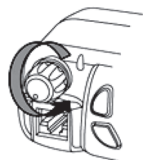



For å slå av radioen, skru av-på/volumknappen til venstre inntil du hører et klikk.



■ Justering av volumet

Volumet justeres med av-på/volumknappen. Skru knappen til ønsket volumnivå.

MENYOVERSIKT

Trykk  for å få tilgang til menyen. Bruk deretter tastene  og  for å velge ønsket funksjon. Trykk  for å bekrefte valget. Bruk tastene  og  for å bla fram ønsket funksjonsvalg og trykk  for å lagre valget.

Trykk 

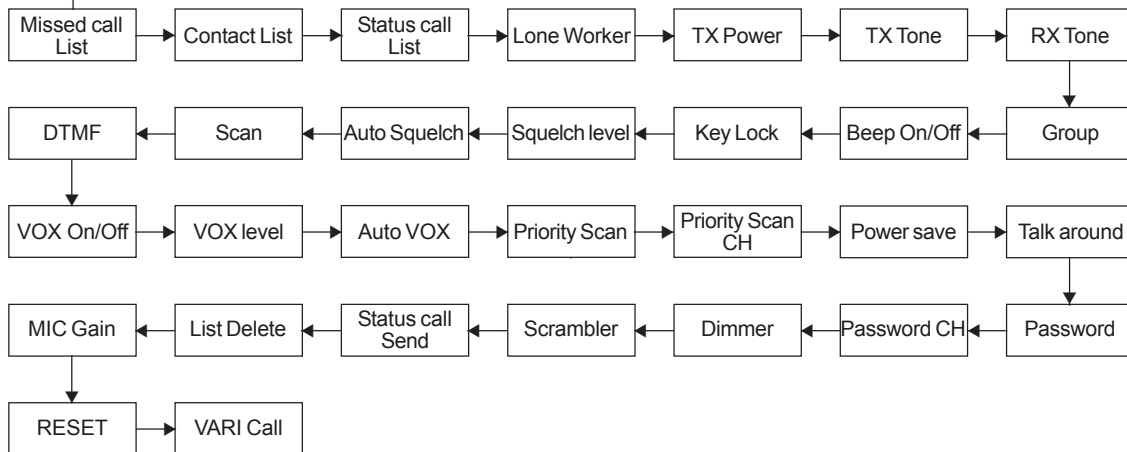



■ FUNKSJONER

■ Kanalvalg

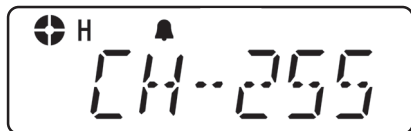
Radioen har opptil 255 kanaler.



Velg ønsket kanal ved å trykke  eller . Hvert trykk øker eller minsker kanalnummeret med et nummer. Hvis du holder tasten nede, øker eller minsker kanalnummeret fortløpende. Kanalene kan angis med alfanumerisk tekst.

■ Sending

Sjekk at den valgte kanalen er ledig før du starter sendingen.

1. Trykk og hold **PTT**-knappen på mikrofonen. Snakk med normal stemme i mikrofonen.
2. Når du er ferdig med å snakke, slipp **PTT**-knappen og radioen går tilbake i lyttestilling.





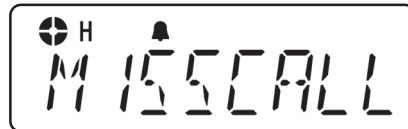

■ Ubesvarte anrop

Hvis et anrop forblir ubesvart, vil anropet bli lagret i listen over ubesvarte anrop.



Inntil 16 anrop kan lagres. Hvis det kommer flere anrop fra samme radio, vil bare det siste anropet bli lagret. Etter at 15 anrop er lagret i listen over ubesvarte anrop, vil neste ubesvarte anrop overskrive det eldste anropet i listen.





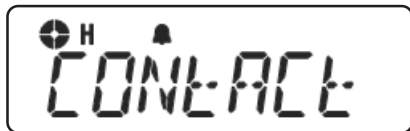

Hvis S vises i displayet, betyr det at en statusmelding følger med anropet.

1. Trykk  for å få tilgang til menyen
2. Bla i menyen med  eller 
3. Velg *MISSCALL* med 
4. Bla i listen med  eller 
5. Velg og bekreft med 

■ Kontaktliste

Under en samtale kan kontaktlisten brukes til å gi tilgang til opptil 60 forhåndsprogrammerte nummer fra menyen. Hvis samme radio anroper flere ganger, vil bare det siste anropet bli lagret. Ved mer enn 60 anrop, vil det første bli overskrevet.









1. Trykk  for å få tilgang til menyen
2. Bla i menyen med  eller 
3. Velg *CONTACT* med 
4. Bla i listen med  eller 
5. Velg og bekreft med 

■ Liste over statusanrop

En status er en kode for overføring av forhåndslagde meldinger, f.eks status «03» kan indikere «lunsj». Forhåndslagde meldinger og tilhørende koder er lagret i en statusliste som kan inneholde inntil 30 meldinger.









1. Trykk  for å få tilgang til menyen
2. Bla i menyen med  eller 
3. Velg *STATUS* med 
4. Bla fram ønsket melding med  eller 
5. Velg og bekreft med 

■ Lone Worker

Lone Worker funksjonen gir deg mulighet til å arbeide alene med større trygghet. Radioen starter nødsekvens hvis ikke brukeren svarer ved å trykke en knapp innen en bestemt tid.









1. Trykk  for å få tilgang til menyen
2. Bla i menyen med  eller 
3. Velg LONEWORK med 
4. Velg On/Off med  eller 
5. Velg og bekreft med 

■ Tx Power

Velg mellom høy, medium eller lav sendereffekt.









1. Trykk  for å få tilgang til menyen
2. Bla i menyen med  eller 
3. Velg TX POWER med 
4. Velg (høy/medium/lav) sendereffekt med  eller 
5. Bekreft valget med 

■ Tx Tone

Funksjonen brukes for å endre Tx tonen, f.eks CTCSS eller DCS.







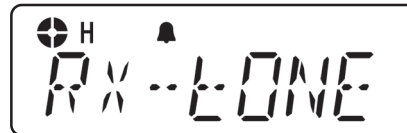

1. Trykk  for å få tilgang til menyen
2. Bla i menyen med  eller 
3. Velg TX TONE med 
4. Velg CTCSS eller DCS med  eller 
5. Bekreft valget med 

■ Rx Tone

Funksjonen brukes for å endre Rx tonen, f.eks CTCSS eller DCS.









1. Trykk  for å få tilgang til menyen
2. Bla i menyen med  eller 
3. Velg RX TONE med 
4. Velg CTCSS eller DCS med  eller 
5. Bekreft valget med 

■ Gruppe

Gruppe gir mulighet for å velge ønsket kanalgruppe, hvis dette er programmert. Du kan da f.eks. velge å scanne ønsket kanalgruppe.









1. Trykk  for å få tilgang til menyen
2. Bla i menyen med  eller 
3. Velg *GROUP* med 
4. Velg gruppe med  eller 
5. Bekreft valget med 

■ Alarmtone

Når alarmtone er innkoblet, vises symbolet  i displayet. Tone gis ved tastetrykk og anrop.









1. Trykk  for å få tilgang til menyen
2. Bla i menyen med  eller 
3. Velg *BEEP* med 
4. Velg On eller Off med  eller 
5. Bekreft valget med 

■ Tastelås

Funksjonen brukes for å forhindre uønskede eller tilfeldige tastetrykk. Når tastelåsen er innkoplet, vises symbolet  i displayet.









1. Trykk  for å få tilgang til menyen
2. Bla i menyen med  eller 
3. Velg KEY LOCK med 
4. Velg lock/unlock key med  eller 
5. Bekreft valget med 

■ Squelch nivå

Funksjonen brukes for å tilpasse radiomottakerens følsomhet manuelt til signalene på kanalen.









1. Trykk  for å få tilgang til menyen
2. Bla i menyen med  eller 
3. Velg SQUELCH LV med 
4. Velg ønsket nivå med  eller 
5. Bekreft valget med 

■ Auto squelch

Funksjonen brukes for å tilpasse mottakerfølsomheten automatisk til signalene på kanalen.







1. Trykk  for å få tilgang til menyen
2. Bla i menyen med  eller 
3. Velg *AUTO SQ* med 
4. Velg On eller Off med  eller 
5. Bekreft valget med 

■ Scanning

Funksjonen brukes til å søke etter kanaler med trafikk. Når funksjonen er innkoplet, vises  symbolet i displayet.









1. Trykk  for å få tilgang til menyen
2. Bla i menyen med  eller 
3. Velg *SCAN* med 
4. Trykk [PTT] for å avslutte.

■ DTMF

Denne funksjonen gir mulighet til å sende en forhåndsprogrammert DTMF-kode for å kontrollere en repeater, åpne squelch på en annen sender, etc.









1. Trykk  for å få tilgang til menyen
2. Bla i menyen med  eller 
3. Velg *DTMF* med 
4. Velg On/Off med  eller 
5. Bekreft valget med 

■ VOX

Funksjonen brukes til automatisk talestyring av senderen.







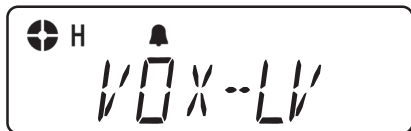

1. Trykk  for å få tilgang til menyen
2. Bla i menyen med  eller 
3. Velg *VOX* med 
4. Velg On eller Off med  eller 
5. Bekreft valget med 

■ VOX nivå

Funksjonen brukes til å tilpasse følsomheten på talestyringen manuelt.









1. Trykk  for å få tilgang til menyen
2. Bla i menyen med  eller 
3. Velg VOX LV med 
4. Velg ønsket nivå med  eller 
5. Bekreft valget med 

■ Auto VOX

Funksjonen brukes til automatisk tilpasning av følsomhet på talestyringen.









1. Trykk  for å få tilgang til menyen
2. Bla i menyen med  eller 
3. Velg AUTO VOX med 
4. Velg On/Off med  eller 
5. Bekreft valget med 

■ Prioritetsscanning

Funksjonen brukes til valg av scanning med prioritetskanal.









1. Trykk  for å få tilgang til menyen
2. Bla i menyen med  eller 
3. Velg P-SCAN med 
4. Velg On/Off med  eller 
5. Bekreft valget med 

■ Prioritetskanal ved scanning

Funksjonen brukes til valg av prioritetskanal ved scanning.









1. Trykk  for å få tilgang til menyen
2. Bla i menyen med  eller 
3. Velg P-SCANCH med 
4. Velg On/Off med  eller 
5. Bekreft valget med 

■ Strømsparing

Funksjonen brukes til å redusere strømforbruket når radioen er i standbystilling.









1. Trykk  for å få tilgang til menyen
2. Bla i menyen med  eller 
3. Velg *PW SAVE* med 
4. Velg On/Off med  eller 
5. Bekreft valget med 

■ Talk Around

Talk Around-funksjonen (direkte samband) gir mulighet til å snakke direkte med en annen radio uten å gå gjennom et system eller repeater. Nyttig hvis repeateren / basestasjonen er ute av drift.









1. Trykk  for å få tilgang til menyen
2. Bla i menyen med  eller 
3. Velg *TKAROUND* med 
4. Velg On/Off med  eller 
5. Bekreft valget med 

■ Passord

Brukes til å slå passordfunksjonen av og på.









1. Trykk  for å få tilgang til menyen
2. Bla i menyen med  eller 
3. Velg *PASSWORD* med 
4. Velg ON/OFF med  eller 
5. Bekreft valget med 

■ Endring av passord

Brukes til å endre passordet.



1. Trykk  for å få tilgang til menyen
2. Bla i menyen med  eller 
3. Velg *PSW CHAR* med 
4. Tast inn gammelt passord med  og 
5. Tast inn nytt passord (4 tegn)

■ Dimmer

Justerer bakgrunnsbelysningens styrke.



1. Trykk for å få tilgang til menyen
2. Bla i menyen med eller
3. Velg *DIM* med
4. Velg nivå 1,2,3,4 med eller
5. Bekreft valget med

■ Scrambler

Scrambler (taleforvrenger) gir høyere kommunikasjonssikkerhet.









1. Trykk for å få tilgang til menyen
2. Bla i menyen med eller
3. Velg *SCRAMBLE* med
4. Velg On/Off med eller
5. Bekreft valget med

■ Statusanrop

Gir mulighet for å sende en bestemt melding (f. eks. «Lunch», «Opptatt» o.l.).







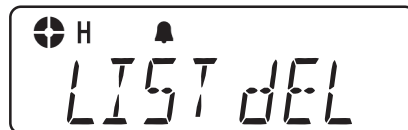

1. Trykk  for å få tilgang til menyen
2. Bla i menyen med  eller 
3. Velg *STAT SEND* med 
4. Velg ønsket Statusmelding med  eller 
5. Trykk [PTT]

■ Slette liste

Funksjonen brukes til å slette listen med tapte anrop (Missed Calls).







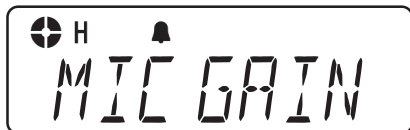

1. Trykk  for å få tilgang til menyen
2. Bla i menyen med  eller 
3. Velg *LIST DEL* med 
4. Velg ON/OFF med  eller 
5. Bekreft valget med 

■ Mikrofon

Funksjonen kontrollerer mikrofonens følsomhetsnivå.







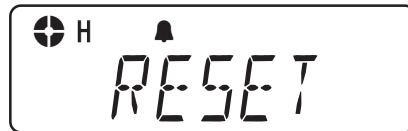

1. Trykk  for å få tilgang til menyen
2. Bla i menyen med  eller 
3. Velg *MIC GAIN* med 
4. Velg ønsket nivå med  eller 
5. Bekreft valget med 

■ Reset

Funksjonen gjenoppretter fabrikkinnstillingene.







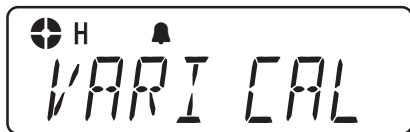

1. Trykk  for å få tilgang til menyen
2. Bla i menyen med  eller 
3. Velg *RESET* med 
4. Velg ON/OFF med  eller 
5. Bekreft valget med 

■ Variable anrop

Funksjonen benyttes til å endre siffer i selektivt anrop.



1. Trykk  for å få tilgang til menyen
2. Bla i menyen med  eller 
3. Velg *VARI CALL* med 
4. Velg siffer i tonekoden (1,2,3-A,B,C,D,E) med 
eller 
5. Bekreft valget med 

TEKNISKE SPESIFIKASJONER

	Proline 80M	Proline 100M	Proline 400M
Generellt			
Maks antall kanaler	255	255	255
Frekvensområde	60 - 88 MHz.	136 - 174 MHz	403 - 470 MHz
Kanalavstand	12,5 / 25 kHz	12,5 / 25 KHz	12,5 / 25 KHz
Kommunikasjonsmåte	Simplex / semiduplex	Simplex / semiduplex	Simplex / semiduplex
Antenne impedanse	50 ohm	50 ohm	50 ohm
Strømforsyning	13,6 VDC	13,6 VDC	13,6 VDC
Strømforbruk, sending (25W)	<6A	<6A	<6A
Strømforbruk, mottaking (3W)	<1A	<1A	<1A
Strømforbruk, standby	<100mA	<100mA	<100mA
Temperaturområde	-30°C - +60°C	-30°C - +60°C	-30°C - +60°C
Størrelse (b x h x d)	178 x 49 x 195 mm	178 x 49 x 195 mm	178 x 49 x 195 mm
Vekt	1600 g	1600 g	1600 g
Mottaker			
Følsomhet (12 dB Sinad)	0,25 uV	0.25 uV	0,25 uV
Støy	45 dB (25 kHz)	45 dB (25 kHz)	45 dB (25 kHz)
Audio effekt @ 5% forvrengning	700 mW @ 16 Ohm	700 mW @ 16 Ohm	700 mW @ 16 Ohm
Sender			
Utgangseffekt	15W / 5W / 2,5W	15W / 5W / 2,5W	15W / 5W / 2,5W
Modulasjon FM	8K50F3E/16K0F3E	8K50F3E/16K0F3E	8K50F3E/16K0F3E
Støy	45 dB (25 kHz)	45 dB (25 kHz)	45 dB (25 kHz)
<i>Spesifikasjonene kan endres uten varsel.</i>			

■ KANALER

■ Frekvenstabell

Radioen er programmerbar, og kan tilpasses nye og eksisterende radionett iht. konsesjon fra Post og Teletilsynet.

■ Pilottonetabell

Pilottone	Hz	Pilottone	Hz	Pilottone	Hz	Pilottone	Hz
001	67,0	013	103,5	025	156,7	037	241,8
002	71,9	014	107,2	026	162,2	038	250,3
003	74,4	015	110,9	027	167,9	039	069,3
004	77,0	016	114,8	028	173,8	040	159,8
005	79,7	017	118,8	029	179,9	041	183,5
006	82,5	018	123,0	030	186,2	042	189,9
007	85,4	019	127,3	031	192,8	043	196,6
008	88,5	020	131,8	032	203,5	044	199,5
009	91,5	021	136,5	033	210,7	045	206,5
010	94,8	022	141,3	034	218,1	046	229,1
011	97,4	023	146,2	035	225,7	047	254,1
012	100,0	024	151,4	036	233,6		

■ TILBEHØR

Som standard leveres radioen med følgende utstyr:

- Radiodel
- Festebrakett
- Mikrofonholder
- Mikrofon
- 12V DC kabel

I tillegg kan det leveres:

- DIN monteringskassett.

■ FEILSØKING

Hvis det oppstår problemer, foreta en resetting av apparatet ved å velge Reset i menyen.

■ VEDLIKEHOLD

Beskytt apparatet mot fuktighet, vann, kulde og ekstrem varme.

Radioen rengjøres med en lett fuktet klut. Bruk ikke rengjørings- eller løsningsmidler som kan skade radioen slik at garantien oppheves.

■ GARANTI

Zodiac Norge AS gir garanti i 12 måneder mot fabrikkasjonsfeil. Utover dette kommer kjøpslovens bestemmelser om reklamasjonsrett. Ved reklamasjon eller garantihenvendelser må dokumentasjon på kjøpsdato fremlegges i form av kjøpskvittering eller lignende. Ved næringskjøp gjelder særskilte regler.

Innenfor garantitiden reparerer Zodiac Norge AS alle feil som var iboende i apparatet i kjøpsøyeblikket, forutsatt at apparatet innleveres hos den forhandler hvor det ble kjøpt, eller til Zodiac's serviceverksted. Eventuell frakt betales av kjøperen. Apparatet må alltid pakkes forsvarlig eller i originalemballasjen ved forsendelsen.

Skader som skyldes feil bruk i henhold til denne bruksanvisningen, slitasje, overspenning, slag, fukt-skade, lynnedslag eller inngrep av uautoriserte personer, faller ikke under noen omstendigheter inn under garantien og vil bli reparert etter ordre fra kjøper mot betaling.

■ SAMSVARSERKLÆRING

Herved erklærer Zodiac Norge A/S at Zodiac Proline M leveres i overensstemmelse med de vesentligste egenskapskrav og øvrige relevante bestemmelser som fremgår av direktiv 1999 / 519 / EC og er laget etter følgende spesifikasjoner:

EN 60950-1

EN 301 489-1/-5

EN 300 086-1/-2

Samsvarserklæringen kan også finnes på vår hjemmeside www.zodiac.no.

Produktet kan brukes i Norge og markedsføres av:

Zodiac Norge A/S

Postboks 4213 Nydalen

0401 Oslo

www.zodiac.no

post@zodiac.no

CE 0678 ⚠

ZODIAC

INNEHÅLL

INTRODUKTION	30	Röststyrning (VOX).....	43
EGENSKAPER	30	Röststyrningskänslighet (manuell).....	44
SÄKERHETSANVISNINGAR	30	Röststyrningskänslighet (automatisk)	44
BESKRIVNING AV STATIONEN	31	Kanalpassning med prioritet.....	45
BESKRIVNING AV DISPLAYEN	32	Val av prioriterad kanal.....	45
BESKRIVNING AV KNAPPARNA	32	Sparläge	46
FÖRBEREDELSE FÖR BRUK	33	Sidokanal.....	46
SLÅ RADION PÅ/AV	34	Lösenord	47
MENYÖVERSIKT	35	Ändring av lösenord	47
FUNKTIONER	36	Displaybelysning.....	48
Val av kanal	36	Talförvrängare	48
Sändning	36	Statusmeddelande	49
Obesvarade anrop	36	Radera lista för obesvarade anrop	49
Kontaktlista	37	Mikrofonförstärkning	50
Lista över statusanrop	37	Återställning	50
Ensamarbete.....	38	Variabelt anrop	51
Sändareffekt	38	TEKNISKA SPECIFIKATIONER	52
Ändra pilotton/DCS på sändning.....	39	KANALER	53
Ändra pilotton/DCS på mottagning.....	39	Frekvenstabell	53
Grupp	40	Pilotontabell	53
Alarmton	40	TILLBEHÖR	54
Knapplås	41	FELSÖKNING	54
Brusspärnivå (manuell).....	41	RENGÖRING	54
Brusspärnivå (automatisk)	42	GARANTI	55
Kanalpassning.....	42	INTYG OM ÖVERENSSTÄMMELSE	55
DTMF.....	43		

■ INTRODUKTION

Zodiac Proline M är en kommunikationsradio byggd för effektivt radiosamband i yrkessammanhang. Den kan anpassas för åtskilliga typer av radionät, då den bl.a. är utrustad med selektivt anropssystem med upp till 7 sekventiella toner. Den är också en helbandsradio, vilket innebär att det kan vara stora frekvensavvikelser mellan kanalerna i det aktuella bandet.

■ EGENSKAPER

Zodiac Proline M är konstruerad för yrkesbruk i krävande miljöer, och avsedd för fordonsmontage. Den är robust och enkel att använda. Den innehåller ett enkelt, men kraftfullt menysystem. Sändaren ger upp till 25W, vilket borgar för god räckvidd. Radion har en kraftig audioförstärkare, som ger ett kristallklart ljud. Displayen har möjlighet för alfanumerisk visning av kanaltexten.

■ SÄKERHETSANVISNINGAR

Det är viktigt att följa några enkla anvisningar vid användning av radion, för att den skall uppnå maximala prestanda och få lång livslängd.

- Ha alltid antennen ansluten vid sändning.
- Apparaten är klassad för att tåla fukt och väta, men bör torkas av om den utsatts för detta.
- Apparaten strömförsörjs från 12 VDC, minimum 6 A. Detta är av vikt för att stationen skall kunna lämna specificerad sändareffekt och fungera väl i övrigt.

BESKRIVNING AV STATIONEN

Till/Från Sändareffekt Alfanumerisk
Volymkontroll Hög/medium/låg LCD display

Kanalpassning

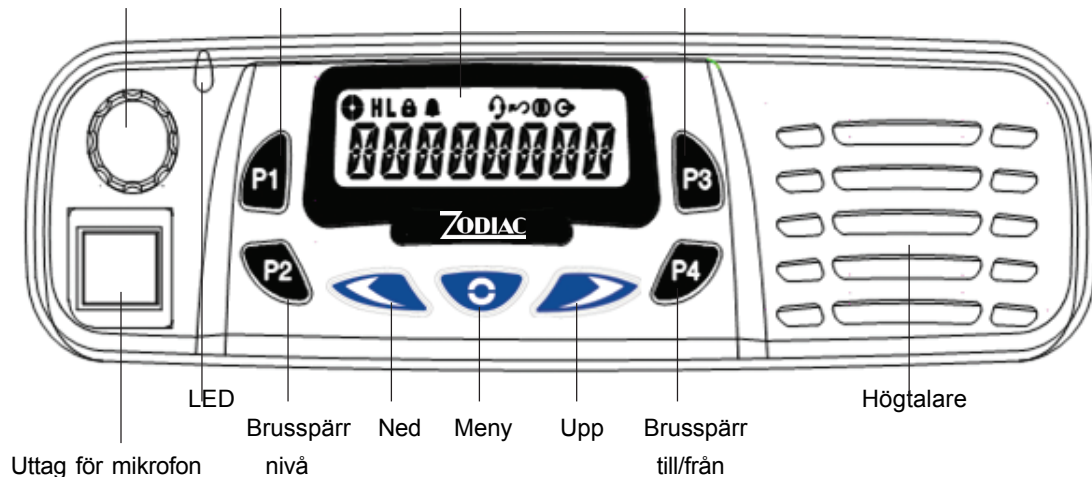



BESKRIVNING AV DISPLAYEN



-  Signalstyrkenivå
- HL** Effektindikator
H = hög sändareffekt
L = låg sändareffekt
M = medium sändareffekt (visas inte i displayen)
-  Knapplåst aktivt
-  Alarmton aktiv
-  Röststyrning (VOX) aktiv
-  Kanalpassning (Scan) aktiv
-  Talförvrängning (Scramble) aktiv
-  Sidokanal (Talk around) aktiv

BESKRIVNING AV KNAPPARNA

-  **Meny-knapp**
Används för att få tillgång till menyn och för att bekräfta menyval.
-  **UPP-knapp**
Väljer önskad kanal eller bläddrar uppåt i menylistan.
-  **NED-knapp**
Väljer önskad kanal eller bläddrar neråt i menylistan.
- P1** Väljer sändareffekt
- P2** Väljer önskad brusspär-nivå
- P3** Startar passning av programmerade kanaler
- P4** Monitor-knapp. Öppnar brusspärren på vald kanal för att höra svaga signaler/sändingar.

Knapparna P1, P2, P3 och P4 kan programmeras efter eget önskemål för att aktivera olika funktioner. Programmeringen sker av din återförsäljare.

■ FÖRBEREDELSE FÖR BRUK

■ Montering av upphängningsbygel

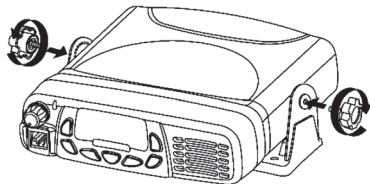

■ Anslutning av strömförsörjningskabel

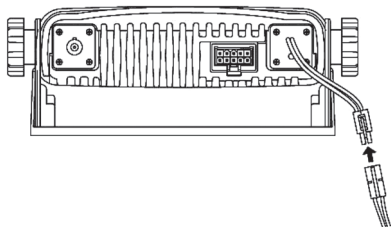

■ In-/urkoppling av handmikrofonen

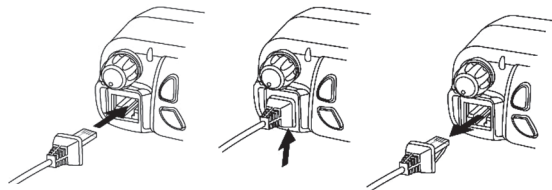

■ Montering av mikrofonhållare

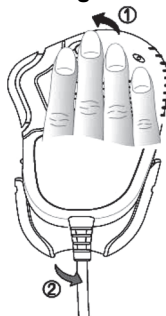

■ STARTA / STÄNGA AV RADION / JUSTERING AV HÖGTALARVOLYM

■ Starta radion

För att starta radion, vrid Till/Från/Volymratten åt höger. Du hör ett klick. Justera sedan högtalarvolymen till önskvärd nivå.

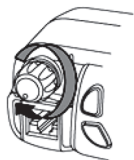

■ Stänga av radion

För att stänga av radion, vrid Till/Från/Volymratten åt vänster tills du hör ett klick.

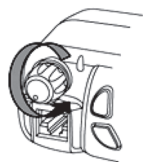

Använd Upp/Ner-knapparna

MENYÖVERSIKT

Tryck  för att få tillgång till menyn. Använd knapparna  och  för att välja önskad funktion. Välj och bekräfta valet med . Använd knapparna  och  och bläddra fram önskad funktion och tryck  för att spara valet.

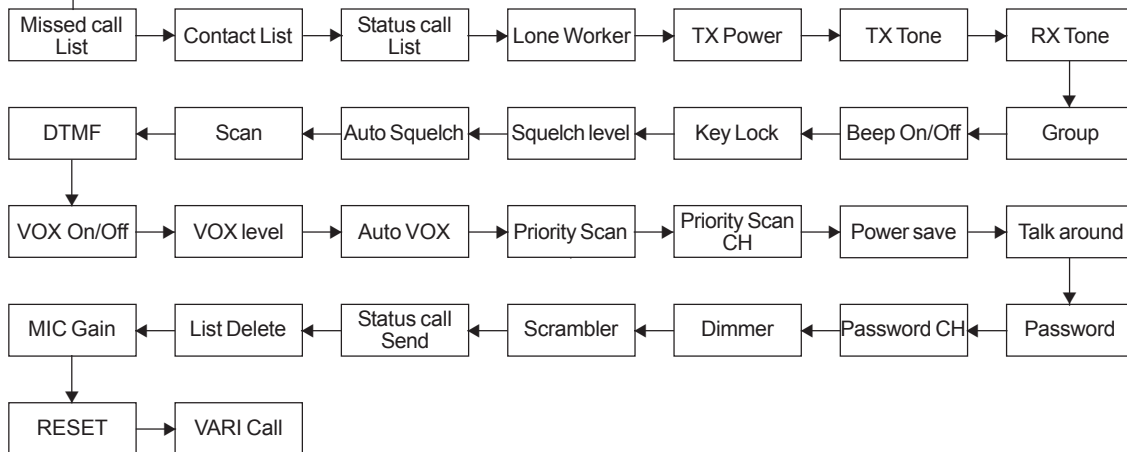

Tryck 

■ FUNKTIONER

■ Kanalväljare

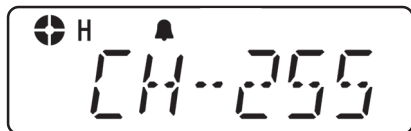
Radion kan programmeras med upp till 255 kanaler.



Välj önskad kanal genom att trycka  eller . För varje tryckning stegar kanalväljaren upp eller ned. Om du håller respektive knapp inne, stegar kanalväljaren fortlöpande automatiskt uppåt eller nedåt. Kanalerna kan visas med alfanumerisk text.

■ Sändning

Kontrollera att den valda kanalen är ledig innan du börjar sända!

1. Tryck och håll inne mikrofonens sändartangent. Tala med normal röst c:a 5 cm från mikrofonen.
2. När du är talat klart, släpp mikrofonens sändartangent, så återgår radion till mottagningsläge.





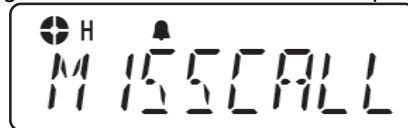

■ Obesvarat anrop (Missed Call)

Om ett selektivt anrop förblir obesvarat, blir anropet lagrat i listan över obesvarade anrop.



Upp till 16 anrop kan lagras. Om det kommer flera anrop från samma radio, blir det senaste anropet lagrat. När anropslistan är full medför nästa inkommande obesvarade anrop att det äldsta anropet i listan raderas.







Om S visas i displayen, betyder det att ett statusmeddelande följer med anropet.

1. Tryck  för att få tillgången till menyn
2. Bläddra i menyn med  eller 
3. Välj *MISSCALL* med 
4. Bläddra i listan med  eller 
5. Välj och bekräfta med 

■ Kontaktlista

I kontaktlistan kan lagras upp till 60 förhandsprogrammerade koder för utgående selektiv-anrop.









1. Tryck  för att få tillgång till menyn
2. Bläddra i menyn med  eller 
3. Välj *CONTACT* med 
4. Bläddra i listan med  eller 
5. Välj och bekräfta med 

■ Lista över statusmeddelanden

En status är en kod för överföring av förhandslagrade meddelanden, t.ex status «05» kan indikera «lunch». Förhandslagrade meddelanden och tillhörande koder är lagrade i en statuslista som kan innehålla upp till 30 meddelanden.









1. Tryck  för att få tillgång till menyn
2. Bläddra i menyn med  eller 
3. Välj *STATUS* med 
4. Bläddra fram önskat meddel. med  eller 
5. Välj och bekräfta med 

■ Ensamarbete (Lone Worker)

Ensamarbetesfunktionen ger dig möjlighet till att arbeta ensam med större trygghet. Du kan välja Lone Worker On och Off genom att använda en förhandsprogrammerad Lone Worker knapp eller via menyn inom en bestämd tidsperiod.









1. Tryck  för att få tillgång till menyn
2. Bläddra i menyn med  eller 
3. Välj *LONEWORK* med 
4. Välj On/Off med  eller 
5. Välj och bekräfta med 

■ Sändareffekt (Tx Power)

Välj mellan hög, medium eller låg sändareffekt.



1. Tryck  för att få tillgång till menyn
2. Bläddra i menyn med  eller 
3. Välj *TX POWER* med 
4. Välj (*hög/medium/låg*) sändareffekt med  eller 
5. Välj och bekräfta med 

■ Ändra pilotton (CTCSS) eller DCS för sändning(Tx)

Funktionen används för att ändra pilotton eller DCS för sändning.



1. Tryck för att få tillgång till menyn
2. Bläddra i menyn med eller
3. Välj TX TONE med
4. Välj CTCSS eller DCS med eller
5. Välj och bekräfta med

■ Ändra pilotton (CTCSS) eller DCS för mottagn.(Rx)

Funktionen används för att ändra pilotton eller DCS för mottagning.









1. Tryck för att få tillgång till menyn
2. Bläddra i menyn med eller
3. Välj RX TONE med
4. Välj CTCSS eller DCS med eller
5. Välj och bekräfta med

■ Grupp

Grupp ger möjlighet till att välja önskad kanalgrupp, om detta är programmerat. Du kan då t.ex. välja att passa önskad kanalgrupp.









1. Tryck  för att få tillgång till menyn
2. Bläddra i menyn med  eller 
3. Välj *GROUP* med 
4. Välj grupp med  eller 
5. Välj och bekräfta med 

■ Alarmton

När alarmton är inkopplad, visas symbolen  i displayen. Ton avges vid knapptryck och anrop.







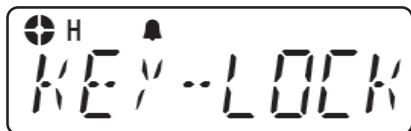

1. Tryck  för att få tillgång till menyn
2. Bläddra i menyn med  eller 
3. Välj *BEEP* med 
4. Välj ON/OFF med  eller 
5. Välj och bekräfta med 

■ Knapplås

Funktionen används för att förhindra oönskade knapptryckningar. När knapplåset är inkopplat, visas symbolen  i displayen.









1. Tryck  för att få tillgång till menyn
2. Bläddra i menyn med  eller 
3. Välj KEY LOCK med 
4. Välj lock/unlock med  eller 
5. Välj och bekräfta med 

■ Brusspärnivå (Squelch)

Funktionen används för att anpassa radiomottagarens känslighet manuellt till signalerna på kanalen.









1. Tryck  för att få tillgång till menyn
2. Bläddra i menyn med  eller 
3. Välj SQUELCH LV med 
4. Välj önskad nivå med  eller 
5. Välj och bekräfta med 

■ Automatisk brusspärrnivå (auto squelch)

Funktionen används för att anpassa mottagarkänsligheten automatiskt till signalerna på kanalen.







1. Tryck  för att få tillgång till menyn
2. Bläddra i menyn med  eller 
3. Välj *AUTO SQ* med 
4. Välj ON/OFF med  eller 
5. Välj och bekräfta med 

■ Kanalpassning (Scanning)

Funktionen används till att söka efter kanaler med trafik. När funktionen är aktiverad, visas  symbolen i displayen.









1. Tryck  för att få tillgång till menyn
2. Bläddra i menyn med  eller 
3. Välj *SCAN* med 
4. Tryck kort på mikrofonens sändartangent för att avsluta

■ DTMF

Denna funktionen ger möjlighet till att sända en förhandsprogrammerad DTMF-kod för att kontrollera en repeater, öppna squelch på en annan sändare, etc.









1. Tryck  för att få tillgång till menyn
2. Bläddra i menyn med  eller 
3. Välj *DTMF* med 
4. Välj ON/OFF med  eller 
5. Välj och bekräfta med 

■ Röststyrning (VOX)

Funktionen används för automatisk röststyrning av sändaren.







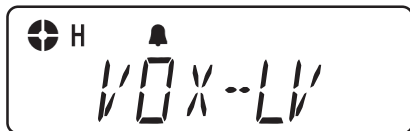

1. Tryck  för att få tillgång till menyn
2. Bläddra i menyn med  eller 
3. Välj *VOX* med 
4. Välj ON/OFF med  eller 
5. Välj och bekräfta med 

■ Röststyrningskänslighet (manuell)

Funktionen används till att anpassa känsligheten på röststyrningen manuellt.









1. Tryck  för att få tillgång till menyn
2. Bläddra i menyn med  eller 
3. Välj VOX LV med 
4. Välj önskad nivå med  eller 
5. Välj och bekräfta med 

■ Röststyrningskänslighet (automatisk)

Funktionen används till automatisk anpassning av känsligheten på röststyrningen.



1. Tryck  för att få tillgång till menyn
2. Bläddra i menyn med  eller 
3. Välj AUTO VOX med 
4. Välj ON/OFF med  eller 
5. Välj och bekräfta med 

■ Kanalpassning (Scanning) med prioritet

Funktionen används till val av passning med prioriterad kanal.



1. Tryck för att få tillgång till menyn
2. Bläddra i menyn med eller
3. Välj P SCAN med
4. Välj ON/OFF med eller
5. Välj och bekräfta med

■ Val av prioriterad kanal

Funktionen används till val av prioriterad kanal vid passning.









1. Tryck för att få tillgång till menyn
2. Bläddra i menyn med eller
3. Välj P SCAN CH med
4. Välj ON/OFF med eller
5. Välj och bekräfta med

■ Sparläge

Funktionen används till att reducera strömförbrukningen när radion är i standby-läge.









1. Tryck  för att få tillgång till menyn
2. Bläddra i menyn med  eller 
3. Välj PW SAVE med 
4. Välj ON/OFF med  eller 
5. Välj och bekräfta med 

■ Sidokanal (Talk Around)

Funktionen ger möjlighet till samtal direkt med en annan radio utan att gå genom ett system eller repeater, t.ex. om repeatern / basstationen är ur drift, eller om stationerna är utanför repeatertäckning.









1. Tryck  för att få tillgång till menyn
2. Bläddra i menyn med  eller 
3. Välj TK AROUND med 
4. Välj ON/OFF med  eller 
5. Välj och bekräfta med 

■ Lösenord (Password)

Används för att koppla in/ur lösenord-funktionen.







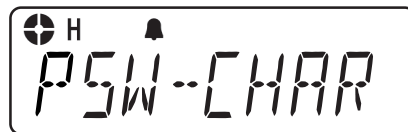

1. Tryck  för att få tillgång till menyn
2. Bläddra i menyn med  eller 
3. Välj *PASSWORD* med 
4. Välj ON/OFF med  eller 
5. Välj och bekräfta med 

■ Ändring av lösenord (Password)

Funktionen används vid ändring av lösenord.









1. Tryck  för att få tillgång till menyn
2. Bläddra i menyn med  eller 
3. Välj *PSW CHAR* med 
4. Knappa in befintl. lösenord med  och 
6. Knappa in nytt lösenord (4 tecken)

■ Displaybelysning

Justerar bakgrundsbelysningens ljusstyrka.









1. Tryck  för att få tillgång till menyn
2. Bläddra i menyn med  eller 
3. Välj *DIM* med 
4. Välj önskad nivå (1,2,3,4) med  eller 
5. Välj och bekräfta med 

■ Talförvrängare (Scrambler)

Talförvrängning ger högre kommunikations-säkerhet.







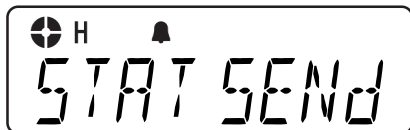

1. Tryck  för att få tillgång till menyn
2. Bläddra i menyn med  eller 
3. Välj *SCRAMBLE* med 
4. Välj ON/OFF med  eller 
5. Välj och bekräfta med 

■ Statusmeddelande

Ger möjlighet att sända ett förutbestämt statusmeddelande, t.ex. «Lunch», «Upptagen» etc.).







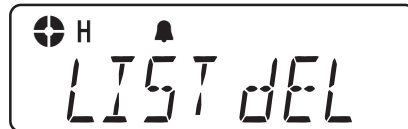

1. Tryck  för att få tillgång till menyn
2. Bläddra i menyn med  eller 
3. Välj *STAT SEND* med 
4. Välj önskat statusmeddel. med  eller 
5. Tryck kort mikrofonens sändartangent

■ Radera lista för obesvarade anrop

Funktionen används för att radera listan över obesvarade anrop (Missed Calls).







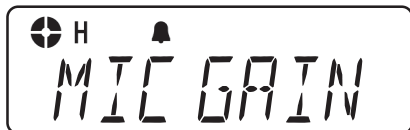

1. Tryck  för att få tillgång till menyn
2. Bläddra i menyn med  eller 
3. Välj *LIST DEL* med 
4. Välj ON/OFF med  eller 
5. Välj och bekräfta med 

■ Mikrofonförstärkning

Funktionen kontrollerar mikrofonens känslighetsnivå.









1. Tryck  för att få tillgång till menyn
2. Bläddra i menyn med  eller 
3. Välj *MIC GAIN* med 
4. Välj önskad nivå med  eller 
5. Välj och bekräfta med 

■ Återställning (Reset)

Återställning av radio till fabriksinställning.







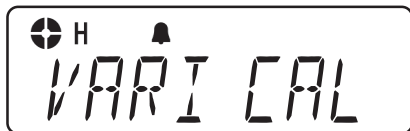

1. Tryck  för att få tillgång till menyn
2. Bläddra i menyn med  eller 
3. Välj *RESET* med 
4. Välj ON/OFF med  eller 
5. Välj och bekräfta med 

■ Variabelt anrop

Funktionen används för att ändra siffror i selektiv anropskod för sändning.



1. Tryck  för att få tillgång till menyn
2. Bläddra i menyn med  eller 
3. Välj VARI CAL med 
4. Välj siffror i tonkoden (1,2,3-A,B,C,D,E) med  eller 
5. Välj och bekräfta med 

TEKNISKA SPECIFIKATIONER

	Proline 80M	Proline 100M	Proline 400M
Generellt			
Max antal kanaler	255	255	255
Frekvensområde	60 - 88 MHz.	136 - 174 MHz	403 - 470 MHz
Kanalseparation	12,5 / 25 kHz	12,5 / 25 KHz	12,5 / 25 KHz
Kommunikationssätt	Simplex / semiduplex	Simplex / semiduplex	Simplex / semiduplex
Antennimpedans	50 ohm	50 ohm	50 ohm
Strömförsörjning	13,6 VDC	13,6 VDC	13,6 VDC
Strömförbrukn, sänding (25W)	<6A	<6A	<6A
Strömförbrukn, mottagning (3W)	<1A	<1A	<1A
Strömförbrukn, standby	<100mA	<100mA	<100mA
Temperaturområde	-30°C - +60°C	-30°C - +60°C	-30°C - +60°C
Storlek (b x h x d)	178 x 49 x 195 mm	178 x 49 x 195 mm	178 x 49 x 195 mm
Vikt	1600 g	1600 g	1600 g
Mottagare			
Känslighet (12 dB SINAD)	0,25 µV	0,25 µV	0,25 µV
Dämpning av FM brum & brus	45 dB (25 kHz)	45 dB (25 kHz)	45 dB (25 kHz)
Audio effekt @ 5% distorsion	700 mW @ 16 Ohm	700 mW @ 16 Ohm	700 mW @ 16 Ohm
Sändare			
Uteffekt	25W / 5W / 2,5W	25W / 5W / 2,5W	25W / 5W / 2,5W
Modulation FM	8K50F3E/16K0F3E	8K50F3E/16K0F3E	8K50F3E/16K0F3E
Dämpning av FM brum & brus	45 dB (25 kHz)	45 dB (25 kHz)	45 dB (25 kHz)
<i>Specifikationen kan ändras utan förvarning.</i>			

■ KANALER

■ Frekvenstabell

Radion är programmerbar, och kan anpassas till nya och befintliga radionnät i enlighet med tillstånd från PTS.

■ Pilotontabell (CTCSS)

Pilotton	Hz	Pilotton	Hz	Pilotton	Hz	Pilotton	Hz
001	67,0	013	103,5	025	156,7	037	241,8
002	71,9	014	107,2	026	162,2	038	250,3
003	74,4	015	110,9	027	167,9	039	069,3
004	77,0	016	114,8	028	173,8	040	159,8
005	79,7	017	118,8	029	179,9	041	183,5
006	82,5	018	123,0	030	186,2	042	189,9
007	85,4	019	127,3	031	192,8	043	196,6
008	88,5	020	131,8	032	203,5	044	199,5
009	91,5	021	136,5	033	210,7	045	206,5
010	94,8	022	141,3	034	218,1	046	229,1
011	97,4	023	146,2	035	225,7	047	254,1
012	100,0	024	151,4	036	233,6		

■ TILLBEHÖR

Som standard levereras radion med följande tillbehör:

- Radiodel
- Upphångningsbygel
- Mikrofon
- Mikrofonhållare
- 12V DC kabel

Som extra tillbehör kan levereras:

- DIN monteringskassett.

■ FELSÖKNING

Om det uppstår problem, gör en fabriksåterställning av radion genom att välja Reset i menyn.

■ RENGÖRING

Skydda radion mot fukt, kraftiga stötar och slag samt extrem värme.

Radion rengörs med en lätt fuktad trasa. Använd inte rengörings- eller lösningsmedel som kan skada radion.

■ GARANTIVILLKOR

Zodiac Tele & Radio AB lämnar garanti på radiodelen i 36 månader avseende fabriktionsfel. Utöver detta gäller konsumentköplagens bestämmelser om reklameringsrätt. Vid återopande av garanti/reklamation skall inköpsdatum dokumenteras med hjälp av faktura, kvitto eller liknande. Vid näringsköp gäller särskilda regler. Garanti på medföljande tillbehör är 12 månader.

Inom garantitiden reparerar Zodiac Tele & Radio AB uppkomna fel, förutsatt att apparaten inlämnas hos den återförsäljare där den inköpts, eller till Zodiacs egen serviceverkstad. Eventuell frakt betalas av köparen. Apparaten skall alltid packas omsorgsfullt eller i originalemballaget vid försändelsen.

Garantin omfattar ej fel som uppkommit genom felaktigt handhavande, normalt slitage, överspänning, yttre åverkan, fuktskada eller ingrepp av icke auktoriserad personal. Zodiac Tele & Radio AB ikläder sig ej några som helst andra åtaganden än de som omnämns under denna rubrik.

■ INTYG OM ÖVERENSSTÄMMELSE

Härmed intygar Zodiac Tele & Radio AB att Zodiac Proline M levereras i överensstämmelse med de väsentligaste egenskapskrav och övriga relevanta bestämmelser som framgår av direktiv 1999 / 519 / EC och är tillverkad efter följande specifikationer:

EN 60950-1

EN 301 489-1/-5

EN 300 086-1/-2

Intyg om överensstämmelse kan också hittas på vår hemsida www.zodiac.se.

Produkten kan användas i Sverige, och marknadsförs av:

Zodiac Tele & Radio AB

Flygfältsgatan 15, 2tr

128 30 Skarpnäck

www.zodiac.se

info@zodiac.se

CE 0678 !

ZODIAC

CONTENTS

INTRODUCTION	57	VOX	70
FEATURES	57	VOX level	71
SAFETY INSTRUCTIONS	57	Auto VOX	71
RADIO OVERVIEW	58	Priority scan	72
DISPLAY AND ICONS	59	Priority scan channel	72
MENU KEYS	59	Power save	73
GETTING STARTED	60	Talk Around	73
RADIO OPERATION	61	Password	74
MENU NAVIGATION CHART	62	Password channel	74
FUNCTIONS	63	Dimmer	75
Selecting a radio channel	63	Scrambler	75
Transmission signal	63	Status call	76
Missed call list	63	List delete	76
Contact list	64	NMIC Gain	77
Status Call list	64	Reset	77
Lone Worker	65	Variable call	78
Tx power	65	TECHNICAL SPECIFICATIONS	79
Tx tone	66	FREQUENCY CHART	80
Rx tone	66	Frequency chart	80
Group	67	CTCSS frequency chart	80
Beep	67	ACCESSORIES	81
Key lock	68	TROUBLESHOOTING	81
Squelch level	68	MAINTENANCE	81
Auto squelch	69	WARRANTY	81
Scanning	69	DECLARATION OF CONFORMITY	82
DTMF	70		

■ INTRODUCTION

Thank you for purchasing the Zodiac Proline M transceiver. Read all instruction carefully and completely before using transceiver. This user manual contains important operating instructions for the transceivers.

■ FEATURES

Zodiac Proline M has a compact size with a various features.





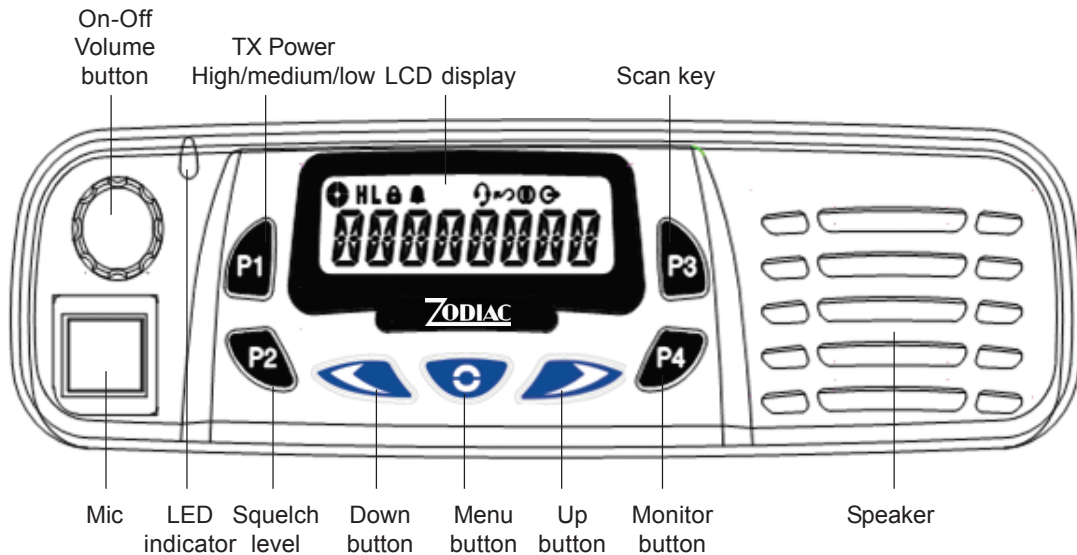

It is constructed with a microprocessor controlled, temperature compensated Phase Locked Loop (PLL) frequency synthesizer. The radio features a double conversation receiver and a direct FM transmitter modulator. A special integrated circuit provides support to sub-audible signalling (CTCSS & DCS) and most of the receiving parts are switched off periodically in the power save mode to reduce battery current drain during standby.

RADIO OVERVIEW





LCD DISPLAY AND ICONS



-  Indicate relative signal strength level
- HL** Power level indicator
H = high power
L = low power
M = medium power (not displayed)
-  Key lock indicator
-  Alert (beep) ON/OFF indicator
-  VOX indicator
-  Scan indicator
-  Scrambler indicator
-  Talk around indicator

MENU KEYS

-  **Menu key**
This key is used to choose menu selection.
-  **Up key**
Select the desired channel or scroll menu function.
-  **Down key**
Select the desired channel or scroll menu function.
- P1** Toggle between high, medium and low power
- P2** Select the desired squelch level
- P3** Start scanning programmed channels
- P4** Monitor - sets the point at which random noise on the channel does not activate the audio circuits but a received signal does. This point is called the squelch threshold.
Further adjustment of the squelch control will degree the reception of wanted transmissions.

All your radio buttons P1, P2, P3 and P4 can be programmed (by programming software) to activate the radio features. Desired function are programmed by your dealer

■ GETTING STARTED

■ Attaching the pedestal

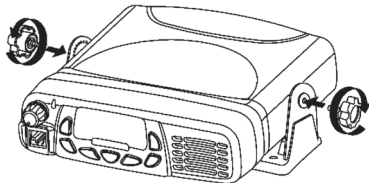

■ Attaching the hand mic

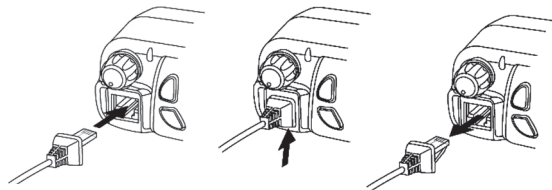

■ Attaching the power cable

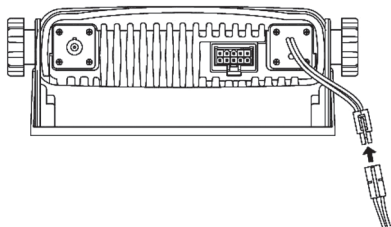

■ Attaching the hand mic pedestal

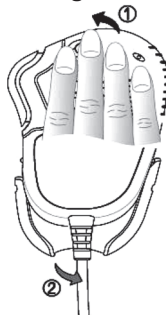

■ RADIO OPERATION

■ Turning the radio On

To turn the radio on, turn the On-Off/Volume control knob clockwise.

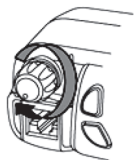

■ Adjusting the radio volume





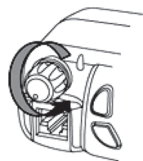

Turn the On-Off/Volume control knob to adjust the volume level.

■ Turning the radio Off

To turn the radio off, turn the On-Off/Volume control knob counterclockwise until you hear a click.



MENU NAVIGATION CHART

Press  to enter menu mode. Use  or  to select desired menu. Press  to confirm. Use  or  to scroll the list and select desired function and press  to select.

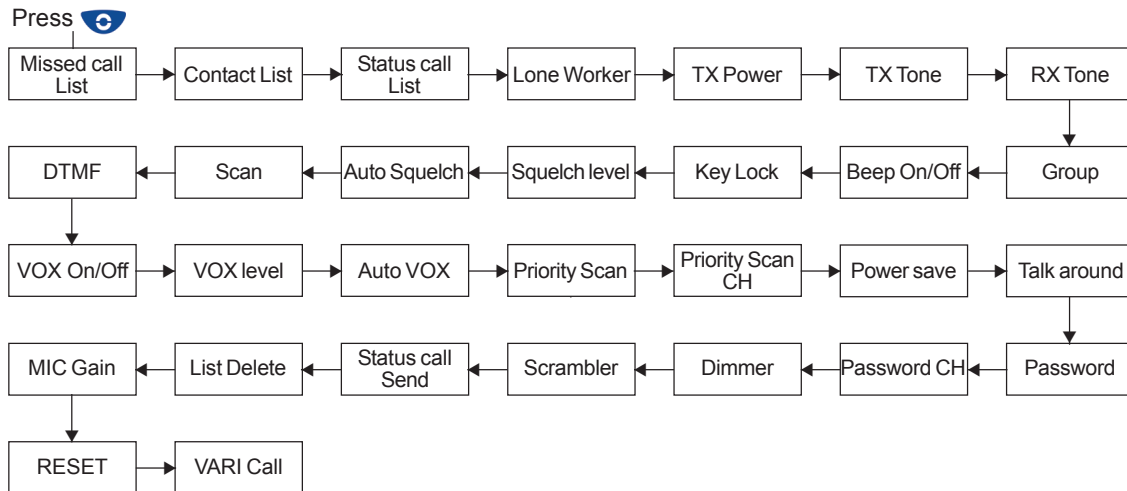



FUNCTIONS

Selecting a radio channel

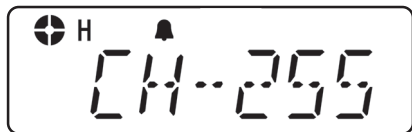
This radio offers up to 255 channels.



Select the desired channel by using the  or  keys. Each press increases or decreases the channel number. When held down, the channels increase or decrease continuously. The channels can be shown with alphanumeric text.

Transmission signal

To transmit, monitor the channel and make sure it is clear.





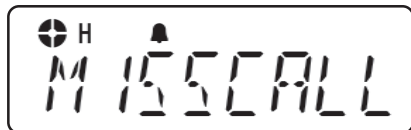

1. To transmit, press and hold in the **PTT** key. Speak into the microphone area of the panel grill in a normal voice level.
2. To return to the Receive mode, release the **PTT** key.

Missed call list

If a call remains unanswered, the call will be stored by the radio, provided that missed calls has been programmed into your radio.



Up to 16 calls can be stored. If the same radio calls more than once, only the most recent call is stored. When fifteen calls have been stored by the radio, depending on the radio programming, the sixteenth may overwrite the first or not be stored by the radio. If the displays shows S there is a status message associated with the call.





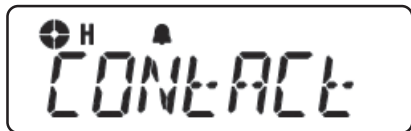

1. Press  to enter menu mode.
2. Use  or  to scroll list until Missed Call list
3. Press  to select *MISSCALL*
4. Use  or  to scroll list
5. Press  to select

■ Contact list

During a call, the contact list may be used to give access to up to 60 preprogrammed numbers accessed via the menu.

Up to 60 calls can be stored. If the same radio calls more than once, only the most recent call is stored.







1. Press  to enter menu mode
2. Use  or  to scroll list until Contact list
3. Press  to select CONTACT
4. Use  or  to scroll list
5. Press  to select

■ Status Calls

A status is a code for transmitting prearranged messages, e.g. status "05" may indicate "lunch". the prearranged messages and associated code digits are contained in a Status List which contains up to 30 entries.









1. Press  to enter menu mode
2. Use  or  to scroll list until Status
3. Press  to select STATUS

■ Lone Worker

The Lone Worker function enables you to work alone with more safety. You can switch On and Off Lone Worker by using a preprogrammed Lone Worker button or through the menu within a limited time of period.







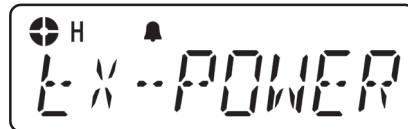

1. Press  to enter menu mode
2. Use  or  to scroll list until Lone Worker
3. Press  to select *LONEWORK*
4. Use  or  to turn ON/OFF
5. Press  to select

■ Tx Power

This function selects high, medium or low power for a channel.







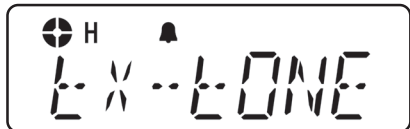

1. Press  to enter menu mode
2. Use  or  to scroll list until TX Power
3. Press  to select *POWER*
4. Use  or  to select High/Medium/Low
5. Press  to select

■ Tx Tone

This function is used to change Tx Tone such as CTCSS, DCS.









1. Press  to enter menu mode
2. Use  or  to scroll list until TX Tone
3. Press  to select *TX TONE*
4. Use  or  to select CTCSS or DCS
5. Press  to select

There are 38 CTCSS code (1-38) and 83 DCS code (101-183)
0 means no Tone.

■ Rx Tone

This function is used to change Rx Tone such as CTCSS, DCS.









1. Press  to enter menu mode
2. Use  or  to scroll list until RX Tone
3. Press  to select *RX TONE*
4. Use  or  to select CTCSS or DCS
5. Press  to select

There are 38 CTCSS code (1-38) and 83 DCS code (101-183)
0 means no Tone.

■ Group

This function enables you to select desired group of channels, if preprogrammed.







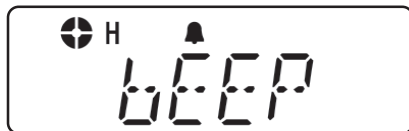

1. Press  to enter menu mode
2. Use  or  to scroll list until Group
3. Press  to select *GROUP*
4. Use  or  to select desired group
5. Press  to select

■ Beep

Alert on/off indicator  appears when beep sound is turned ON.









1. Press  to enter menu mode
2. Use  or  to scroll list until Beep
3. Press  to select *BEEP*
4. Use  or  to turn ON/OFF
5. Press  to select

■ Key Lock

Key Lock indicator  appears during key lock function is ON.









1. Press  to enter menu mode
2. Use  or  to scroll list until Key Lock
3. Use  to select KEY LOCK
4. Use  or  to select lock/unlock key
5. Press  to select

■ Squelch level

This function is used to manually adapt the sensitivity level of the receiver to the signals used on the channel.



1. Press  to enter menu mode
2. Use  or  to scroll list until Squelch level
3. Use  to select SQUELCH LV
4. Use  or  to select desired level
5. Press  to select

■ Auto squelch

This function is used to automatically adapt the sensitivity level of the receiver to the signals used on the channel.



1. Press to enter menu mode
2. Use or to scroll list until Auto Squelch
3. Press to select *AUTO SQ*
4. Use or to turn ON/OFF
5. Press to select

■ Scanning

This function is used to search for channels in use. The scan indicator appears when Scan function is activated.









1. Press to enter menu mode
2. Use or to scroll list until Scan
3. Press to select *SCAN*
4. Push [PTT] to exit

■ DTMF

This function allows you to send a preprogrammed DTMF code to control a repeater, open another transceiver's squelch, etc.









1. Press  to enter menu mode
2. Use  or  to scroll list until DTMF
3. Press  to select *DTMF*
4. Use  or  to turn ON/OFF
5. Press  to select

■ VOX

VOX function (Voice Operated Transmit) is used to operate in hands-free mode without pressing PTT.









1. Press  to enter menu mode
2. Use  or  to scroll list until VOX
3. Press  to select VOX
4. Use  or  to turn ON/OFF
5. Press  to select

■ VOX level

This function is used to manually adapt the sensitivity of the voice operated transmitting.









1. Press  to enter menu mode
2. Use  or  to scroll list until VOX Level
3. Press  to select VOX LV
4. Use  or  to select desired level
5. Press  to select

■ Auto VOX

This function is used to automatically adapt the sensitivity of the voice operated transmitting.









1. Press  to enter menu mode
2. Use  or  to scroll list until Auto VOX
3. Press  to select AUTO VOX
4. Use  or  to turn ON/OFF
5. Press  to select

■ Priority Scan

This function is used to select scanning of a priority channel.









1. Press  to enter menu mode
2. Use  or  to scroll list until Priority Scan
3. Press  to select *P SCAN*
4. Use  or  to turn ON/OFF
5. Press  to select

■ Priority Scan Channel

This function is used to select a priority channel for scanning.









1. Press  to enter menu mode
2. Use  or  to scroll list until Priority Scan Channel
3. Press  to select *P SCANCH*
4. Use  or  to select desired channel
5. Press  to select

■ Power Save

This function is used to reduce the power consumption during standby.









1. Press  to enter menu mode
2. Use  or  to scroll list until Power Save
3. Press  to select *PW SAVE*
4. Use  or  to turn ON/OFF
5. Press  to select

■ Talk Around

This function enables you to talk directly with another radio without going through a system or **dispatcher**.









1. Press  to enter menu mode
2. Use  or  to scroll list until Talk Around
3. Press  to select *TKAROUND*
4. Use  or  to turn ON/OFF
5. Press  to select

■ Password

This function turn on/off the use of password and is useful for security reason.









1. Press  to enter menu mode
2. Use  or  to scroll list until Password
3. Press  to select *PASSWORD*
4. Use  or  to select ON/OFF
5. Press  to select

■ Password Char

This function change the password.









1. Press  to enter menu mode
2. Use  or  to scroll list until Password CH
3. Press  to select *PSW CHAR*
4. --- will display on the display (enter old password)
5. Use  or  to change password
5. Press  to change digit of password
6. Enter new password by 4 digit

■ Dimmer

Control the back light for brightness.









1. Press  to enter menu mode
2. Use  or  to scroll list until Dimmer
3. Press  to select *DIM*
4. Use  or  to select desired level (1-4)
5. Press  to select

■ Scrambler

This function provides higher communication security.









1. Press  to enter menu mode
2. Use  or  to scroll list until Scrambler
3. Press  to select *SCRAMBLE*
4. Use  or  to turn ON/OFF
5. Press  to select

■ Status Call Send

A status is a code for transmitting prearranged messages, e.g. staus "03" may indicate "lunch".







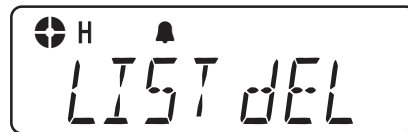

1. Press  to enter menu mode
2. Use  or  to scroll list until Status Call Send
3. Press  to select *STAT SEND*
4. Use  or  to select desired message
5. Press [PTT] to send the message

■ List Delete

This function delete the Missed Call List.







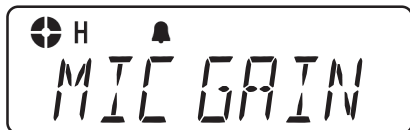

1. Press  to enter menu mode
2. Use  or  to scroll list until LIST DELETE
3. Press  to select *LIST DEL*
4. Use  or  to select ON/OFF
5. Press  to select

■ MIC Gain

Control microphone sensitivity level.







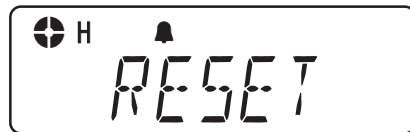

1. Press  to enter menu mode
 2. Use  or  to scroll list until Mic Gain
 3. Press  to select *MIC GAIN*
 4. Use  or  to select HIGH/LOW
 5. Press  to select
- HIGH is high sensitivity and LOW is normal sensitivity.

■ Reset

This function reset the station to default settings.







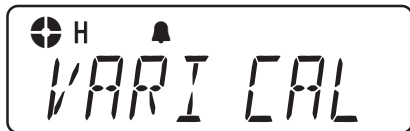

1. Press  to enter menu mode
2. Use  or  to scroll list until RESET
3. Press  to select *RESET*
4. Use  or  to select ON/OFF
5. Press  to select

■ Variable Call

This function enables to change the digits in selective calls.



1. Press  to enter menu mode
2. Use  or  to scroll list until VARIABLE CALL
3. Press  to select VARI CAL
4. Use  or  to select 1,2,3-A,B,C,D,E
5. Press  to select

■ TECHNICAL SPECIFICATIONS

	Proline 80M	Proline 100M	Proline 400M
General			
Channels	255	255	255
Frequency range	60 - 88 MHz.	136 - 174 MHz	403 - 470 MHz
Channel spacing	12,5 / 25 kHz	12,5 / 25 KHz	12,5 / 25 KHz
Communication method	Simplex / semiduplex	Simplex / semiduplex	Simplex / semiduplex
Antenna impedance	50 ohm	50 ohm	50 ohm
Power supply voltage	13,6 VDC	13,6 VDC	13,6 VDC
Current drain, transmitting (25W)	<6A	<6A	<6A
Current drain, receiving (3W)	<1A	<1A	<1A
Current drain, standby	<100mA	<100mA	<100mA
Operating temperature range	-30°C - +60°C	-30°C - +60°C	-30°C - +60°C
Size (b x h x d)	178 x 49 x 195 mm	178 x 49 x 195 mm	178 x 49 x 195 mm
Weight	1600 g	1600 g	1600 g
Receiver			
Sensitivity (12 dB Sinad)	0,25 uV	0.25 uV	0,25 uV
Noise	45 dB (25 kHz)	45 dB (25 kHz)	45 dB (25 kHz)
Audio power @ 5% distortion	700 mW @ 16 Ohm	700 mW @ 16 Ohm	700 mW @ 16 Ohm
Transmitter			
Power Output	15W / 5W / 2,5W	15W / 5W / 2,5W	15W / 5W / 2,5W
Modulation	8K50F3E/16K0F3E	8K50F3E/16K0F3E	8K50F3E/16K0F3E
Noise	45 dB (25kHz)	45 dB (25 kHz)	45 dB (25 kHz)

■ FREQUENCY CHART

■ DCS Frequency Chart

The station can be programmed and adapt new or existing radio network according to licence from the PT.

■ CTCSS Frequency Chart

CTCSS	Hz	CTCSS	Hz	CTCSS	Hz	CTCSS	Hz
001	67,0	013	103,5	025	156,7	037	241,8
002	71,9	014	107,2	026	162,2	038	250,3
003	74,4	015	110,9	027	167,9	039	069,3
004	77,0	016	114,8	028	173,8	040	159,8
005	79,7	017	118,8	029	179,9	041	183,5
006	82,5	018	123,0	030	186,2	042	189,9
007	85,4	019	127,3	031	192,8	043	196,6
008	88,5	020	131,8	032	203,5	044	199,5
009	91,5	021	136,5	033	210,7	045	206,5
010	94,8	022	141,3	034	218,1	046	229,1
011	97,4	023	146,2	035	225,7	047	254,1
012	100,0	024	151,4	036	233,6		

■ ACCESSORIES

The package include the following items:

- The radio
- Mounting pedestal
- Mic Pedestal
- Hand mic
- 12VDC cable

Optional:

- DIN mounting cartridge

■ TROUBLESHOOTING

If you have problems with your station, reset the radio by selecting the Reset in the menu.

■ MAINTENANCE

To clean your station, use a soft cloth dampened with water. Do not use cleaners or solvents which may cause permanent damage which is not covered by the guarantee.

■ WARRANTY

Zodiac will give 12 months warranty against failures made by the manufacturer from the date of purchase. The warranty will not cover damage made by the user, the user opening the equipment, moist, dirt, heat or cold. The warranty will not cover lightning/overvoltage.

Please, contact your dealer if a problem with the equipment arises.

■ DECLARATION OF CONFORMITY

Zodiac hereby declares that Zodiac Proline W conforms to the major characteristic specifications and other relevant specifications given in the Directive 1999 / 519 / EC and is made after following specifications:

EN 60950-1

EN 301 489-1/-5

EN 300 086-1/-2

Zodiac Norge A/S
Postboks 4213 Nydalen
0401 Oslo
www.zodiac.no
post@zodiac.no

CE 0678 

ZODIAC

ZODIAC
www.zodiac.no
www.zodiac.se